



Exchangeable Head Drill

PXD

Volume 2



FEATURES: PHOENIX PXD



1 Cutting edges designed especially for large-diameter drilling. Internal coolant capability enables highly efficient drilling.

2 Exchangeable head can be securely mounted without screws.

3 O.D. relief grinding prevents the curling of chips during drilling.

4 Polished flutes enable smooth chip evacuation.

OSG's proprietary WDI® coating engineered exclusively for PXD

- The WDI coating on the PXD prevents margin wear, thereby enabling high speed drilling and prolonging tool life.

	Coating Structure	Thickness (µm)	Surface Hardness (HV)	Oxidation Temperature (c°)
WDI coating exclusive for PXD	Multiple Layer	7	3.300	1,100
TiAlN Coating	Dual Layer	4	2.700	800

Exchangeable head selection based on work material

	Low Carbon Steel	Medium Carbon Steel	High Carbon Steel	Alloy Steel	Hardened Steel		Cast Iron	Ductile Cast Iron	Copper Alloy	Aluminum Alloy Casting
	C~0,25%	C0,25~0,45%	C0,45%~	SCM	~35HRC	35~45HRC	FC	FCD	Cu	AC-ADC
PC for Steel	⊙	⊙	⊙	○	○	○	○	○		
KC for Cast Iron	○	○	○	○	○		⊙	⊙		
NC for Nonferrous Metal									○	⊙



TAP PILOT HOLE SIZE CHART

Tap drill hole sizes for cutting tap and PXD head

Thread size				Recommended tap drill hole dia.	Drilling Dia		Applicable PXD Head
					Min	Max	
M 16	x	2		14	13,84	14,2	PXDH1400...
M 16	x	1,5		14,5	14,38	14,67	PXDH1450...
M 18	x	2,5		15,5	15,3	15,74	PXDH1550...
M 18	x	1,5		16,5	16,38	16,67	PXDH1650...
M 20	x	2,5		17,5	17,3	17,74	PXDH1750...
M 20	x	1,5		18,5	18,38	18,67	PXDH1850...
M 22	x	2,5		19,5	19,3	19,74	PXDH1950...
M 22	x	1,5		20,5	20,38	20,67	PXDH2050...
M 24	x	3		21	20,76	21,25	PXDH2100...
M 24	x	1,5		22,5	22,38	22,67	PXDH2250...
M 27	x	3		24	23,76	24,25	PXDH2400...

Tap drill hole sizes for forming tap and PXD head (PXD-3D type)

Thread size				Recommended tap drill hole dia.	Drilling Dia		Applicable PXD Head
					Min	Max	
M 16	x	2		14,95	14,92	15,04	PXDH1495...
M 16	x	1,5		15,25	15,21	15,3	PXDH1525...
M 18	x	2,5		16,7	16,63	16,78	PXDH1670...
M 18	x	1,5		17,25	17,22	17,31	PXDH1725...
M 20	x	2,5		18,7	18,63	18,78	PXDH1870...
M 20	x	1,5		19,25	19,22	19,31	PXDH1925...
M 22	x	2,5		20,7	20,63	20,78	PXDH2070...
M 22	x	1,5		21,25	21,22	21,31	PXDH2125...
M 24	x	3		22,4	22,36	22,53	PXDH2240...
M 24	x	1,5		23,25	23,22	23,31	PXDH2325...
M 27	x	3		25,4	25,36	25,53	PXDH2540...

Drilling | Indexable

PROCESSING DATA

Long tool life in SS400

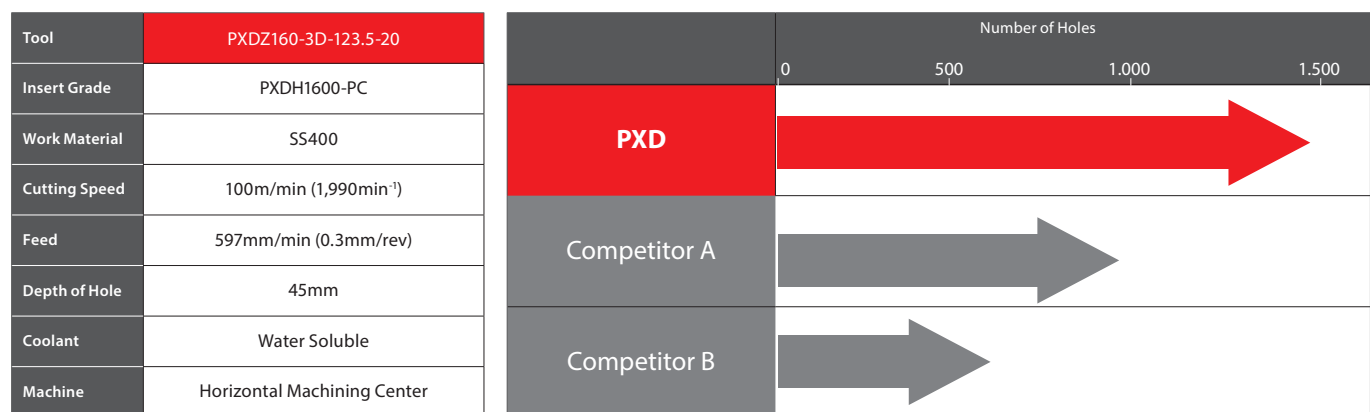

When drilling in SS400, OSG's proprietary WDI coating minimized tool wear, permitting 1.8 times the tool life versus the competition.

Wear comparison after drilling 900 holes of drilling

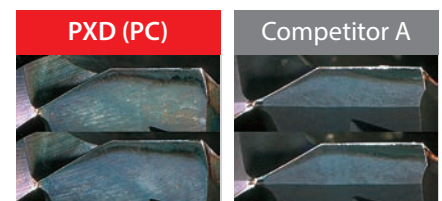

PXD-3D

Drilling | Indexable | Body

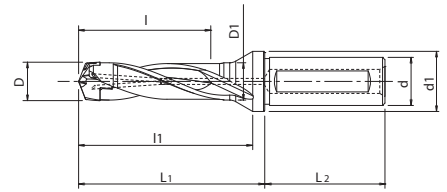

- Exchangeable head drill with internal coolant
- Up to 3xD
- 3 different solid carbide head types based on work material
- 13 sizes
- Including driver

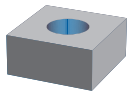

EDP	Designation	Min. drilling Ø	Max. drilling Ø	Seat size	D	l	l1	L1	L2	d	d1	Price
48173001	PXDZ140-3D-113,5-16	14	14,49	PXDH1400... - PXDH1440...	13,5	43	63,4	69,9	48	16	20	
48173002	PXDZ145-3D-115,5-16	14,5	14,99	PXDH1450... - PXDH1495...	14	44,5	65,5	72	48	16	20	
48173003	PXDZ150-3D-119,5-20	15	15,99	PXDH1500... - PXDH1590...	14,5	46,5	67,1	73,6	50	20	25	
48173004	PXDZ160-3D-123,5-20	16	16,99	PXDH1600... - PXDH1690...	15,5	49,5	71,7	78,2	50	20	25	
48173005	PXDZ170-3D-128,5-20	17	17,99	PXDH1700... - PXDH1790...	16,5	52,5	76,8	83,3	50	20	25	
48173006	PXDZ180-3D-138,5-25	18	18,99	PXDH1800... - PXDH1890...	17,5	55,5	81,4	87,9	56	25	32	
48173007	PXDZ190-3D-142,5-25	19	19,99	PXDH1900... - PXDH1990...	18,5	58,5	85,4	91,9	56	25	32	
48173008	PXDZ200-3D-146,5-25	20	20,99	PXDH2000... - PXDH2090...	19,5	61,5	90,1	96,6	56	25	32	
48173009	PXDZ210-3D-154,5-32	21	21,99	PXDH2100... - PXDH2190...	20,5	64,5	94,7	101,2	60	32	42	
48173010	PXDZ220-3D-158,5-32	22	22,99	PXDH2200... - PXDH2290...	21,5	67,5	98,8	105,3	60	32	42	
48173011	PXDZ230-3D-162,5-32	23	23,99	PXDH2300... - PXDH2390...	22,5	70,5	103,4	109,9	60	32	42	
48173012	PXDZ240-3D-167,5-32	24	24,99	PXDH2400... - PXDH2490...	23,5	73,5	108,4	114,9	60	32	42	
48173013	PXDZ250-3D-170,5-32	25	25,99	PXDH2500... - PXDH2540...	24,5	76,5	112	118,5	60	32	42	

Accessories

Applicable head Ø	Driver	Sheet thickness
Ø 14 - 18,9	7808282	1,5
Ø 19 - 22,9	7808283	1,8
Ø 23 - 25,4	7808284	2

Drilling | Indexable



Body

PXD-5D

Drilling | Indexable | Body

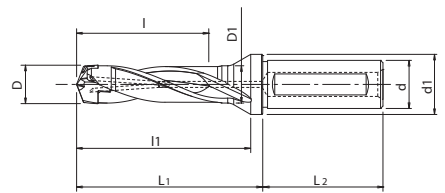

- Exchangeable head drill with internal coolant
- Up to 5xD
- 3 different solid carbide head types based on work material
- 13 sizes
- Including driver

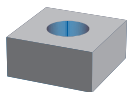

EDP	Designation	Min. drilling Ø	Max. drilling Ø	Seat size	D	I	I1	L1	L2	d	d1	Price
48173014	PXDZ140-5D-141,5-16	14	14,49	PXDH1400... - PXDH1440...	13,5	71,2	92,9	97,9	48	16	20	
48173015	PXDZ145-5D-144,5-16	14,5	14,99	PXDH1450... - PXDH1495...	14	73,7	96	101	48	16	20	
48173016	PXDZ150-5D-149,5-20	15	15,99	PXDH1500... - PXDH1590...	14,5	77,5	97,1	103,6	50	20	25	
48173017	PXDZ160-5D-155,5-20	16	16,99	PXDH1600... - PXDH1690...	15,5	82,5	103,7	110,2	50	20	25	
48173018	PXDZ170-5D-162,5-20	17	17,99	PXDH1700... - PXDH1790...	16,5	87,5	110,8	117,3	50	20	25	
48173019	PXDZ180-5D-174,5-25	18	18,99	PXDH1800... - PXDH1890...	17,5	92,5	117,4	123,9	56	25	32	
48173020	PXDZ190-5D-180,5-25	19	19,99	PXDH1900... - PXDH1990...	18,5	97,5	123,4	129,9	56	25	32	
48173021	PXDZ200-5D-186,5-25	20	20,99	PXDH2000... - PXDH2090...	19,5	102,5	130,1	136,6	56	25	32	
48173022	PXDZ210-5D-196,5-32	21	21,99	PXDH2100... - PXDH2190...	20,5	107,5	136,7	143,2	60	32	42	
48173023	PXDZ220-5D-202,5-32	22	22,99	PXDH2200... - PXDH2290...	21,5	112,5	142,8	149,3	60	32	42	
48173024	PXDZ230-5D-208,5-32	23	23,99	PXDH2300... - PXDH2390...	22,5	117,5	149,4	155,9	60	32	42	
48173025	PXDZ240-5D-215,5-32	24	24,99	PXDH2400... - PXDH2490...	23,5	122,5	156,4	162,9	60	32	42	
48173026	PXDZ250-5D-220,5-32	25	25,99	PXDH2500... - PXDH2540...	24,5	127,5	162	168,5	60	32	42	

Drilling | Indexable

Body

Accessories

Applicable head Ø	Driver	Sheet thickness
Ø 14 - 18,9	7808282	1,5
Ø 19 - 22,9	7808283	1,8
Ø 23 - 25,4	7808284	2

PXD HEADS

Drilling | Indexable | Inserts & Heads

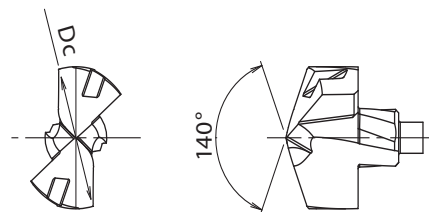
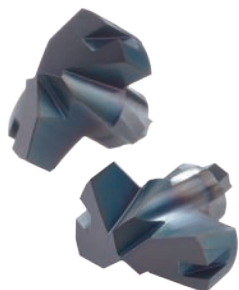

- Applicable head for steel

EDP	Designation	Grade	Dc	Applicable body	P		Price
					dry	water	
7831140	PXDH1400-PC	XP3425	14	PXDZ140...	●	●	
special	PXDH1410-PC	XP3425	14,1	PXDZ140...	●	●	
special	PXDH1420-PC	XP3425	14,2	PXDZ140...	●	●	
special	PXDH1430-PC	XP3425	14,3	PXDZ140...	●	●	
special	PXDH1440-PC	XP3425	14,4	PXDZ140...	●	●	
7831145	PXDH1450-PC	XP3425	14,5	PXDZ145...	●	●	
special	PXDH1460-PC	XP3425	14,6	PXDZ145...	●	●	
special	PXDH1470-PC	XP3425	14,7	PXDZ145...	●	●	
special	PXDH1480-PC	XP3425	14,8	PXDZ145...	●	●	
special	PXDH1490-PC	XP3425	14,9	PXDZ145...	●	●	
7831351	PXDH1495-PC	XP3425	14,95	PXDZ145...	●	●	
7831150	PXDH1500-PC	XP3425	15	PXDZ150...	●	●	
special	PXDH1510-PC	XP3425	15,1	PXDZ150...	●	●	
special	PXDH1520-PC	XP3425	15,2	PXDZ150...	●	●	
7831352	PXDH1525-PC	XP3425	15,25	PXDZ150...	●	●	
special	PXDH1530-PC	XP3425	15,3	PXDZ150...	●	●	
special	PXDH1540-PC	XP3425	15,4	PXDZ150...	●	●	
7831155	PXDH1550-PC	XP3425	15,5	PXDZ150...	●	●	
special	PXDH1560-PC	XP3425	15,6	PXDZ150...	●	●	
special	PXDH1570-PC	XP3425	15,7	PXDZ150...	●	●	
special	PXDH1580-PC	XP3425	15,8	PXDZ150...	●	●	
special	PXDH1590-PC	XP3425	15,9	PXDZ150...	●	●	
7831160	PXDH1600-PC	XP3425	16	PXDZ160...	●	●	
special	PXDH1610-PC	XP3425	16,1	PXDZ160...	●	●	
special	PXDH1620-PC	XP3425	16,2	PXDZ160...	●	●	
special	PXDH1630-PC	XP3425	16,3	PXDZ160...	●	●	
special	PXDH1640-PC	XP3425	16,4	PXDZ160...	●	●	
7831165	PXDH1650-PC	XP3425	16,5	PXDZ160...	●	●	
special	PXDH1660-PC	XP3425	16,6	PXDZ160...	●	●	
7831167	PXDH1670-PC	XP3425	16,7	PXDZ160...	●	●	
special	PXDH1680-PC	XP3425	16,8	PXDZ160...	●	●	
special	PXDH1690-PC	XP3425	16,9	PXDZ160...	●	●	
7831170	PXDH1700-PC	XP3425	17	PXDZ170...	●	●	
special	PXDH1710-PC	XP3425	17,1	PXDZ170...	●	●	
special	PXDH1720-PC	XP3425	17,2	PXDZ170...	●	●	
7831353	PXDH1725-PC	XP3425	17,25	PXDZ170...	●	●	
special	PXDH1730-PC	XP3425	17,3	PXDZ170...	●	●	
special	PXDH1740-PC	XP3425	17,4	PXDZ170...	●	●	
7831175	PXDH1750-PC	XP3425	17,5	PXDZ170...	●	●	
special	PXDH1760-PC	XP3425	17,6	PXDZ170...	●	●	
special	PXDH1770-PC	XP3425	17,7	PXDZ170...	●	●	
special	PXDH1780-PC	XP3425	17,8	PXDZ170...	●	●	
special	PXDH1790-PC	XP3425	17,9	PXDZ170...	●	●	
7831180	PXDH1800-PC	XP3425	18	PXDZ180...	●	●	
special	PXDH1810-PC	XP3425	18,1	PXDZ180...	●	●	
special	PXDH1820-PC	XP3425	18,2	PXDZ180...	●	●	
special	PXDH1830-PC	XP3425	18,3	PXDZ180...	●	●	
special	PXDH1840-PC	XP3425	18,4	PXDZ180...	●	●	
7831185	PXDH1850-PC	XP3425	18,5	PXDZ180...	●	●	
special	PXDH1860-PC	XP3425	18,6	PXDZ180...	●	●	
7831187	PXDH1870-PC	XP3425	18,7	PXDZ180...	●	●	
special	PXDH1880-PC	XP3425	18,8	PXDZ180...	●	●	
special	PXDH1890-PC	XP3425	18,9	PXDZ180...	●	●	
7831190	PXDH1900-PC	XP3425	19	PXDZ190...	●	●	
special	PXDH1910-PC	XP3425	19,1	PXDZ190...	●	●	
special	PXDH1920-PC	XP3425	19,2	PXDZ190...	●	●	
7831354	PXDH1925-PC	XP3425	19,25	PXDZ190...	●	●	
special	PXDH1930-PC	XP3425	19,3	PXDZ190...	●	●	
special	PXDH1940-PC	XP3425	19,4	PXDZ190...	●	●	
7831195	PXDH1950-PC	XP3425	19,5	PXDZ190...	●	●	
special	PXDH1960-PC	XP3425	19,6	PXDZ190...	●	●	

EDP	Designation	Grade	Dc	Applicable body	P		Price
					dry	water	
special	PXDH1970-PC	XP3425	19,7	PXDZ190...	●	●	
special	PXDH1980-PC	XP3425	19,8	PXDZ190...	●	●	
special	PXDH1990-PC	XP3425	19,9	PXDZ190...	●	●	
7831200	PXDH2000-PC	XP3425	20	PXDZ200...	●	●	
special	PXDH2010-PC	XP3425	20,1	PXDZ200...	●	●	
special	PXDH2020-PC	XP3425	20,2	PXDZ200...	●	●	
special	PXDH2030-PC	XP3425	20,3	PXDZ200...	●	●	
special	PXDH2040-PC	XP3425	20,4	PXDZ200...	●	●	
7831205	PXDH2050-PC	XP3425	20,5	PXDZ200...	●	●	
special	PXDH2060-PC	XP3425	20,6	PXDZ200...	●	●	
7831207	PXDH2070-PC	XP3425	20,7	PXDZ200...	●	●	
special	PXDH2080-PC	XP3425	20,8	PXDZ200...	●	●	
special	PXDH2090-PC	XP3425	20,9	PXDZ200...	●	●	
7831210	PXDH2100-PC	XP3425	21	PXDZ210...	●	●	
special	PXDH2110-PC	XP3425	21,1	PXDZ210...	●	●	
special	PXDH2120-PC	XP3425	21,2	PXDZ210...	●	●	
7831355	PXDH2125-PC	XP3425	21,25	PXDZ210...	●	●	
special	PXDH2130-PC	XP3425	21,3	PXDZ210...	●	●	
special	PXDH2140-PC	XP3425	21,4	PXDZ210...	●	●	
7831215	PXDH2150-PC	XP3425	21,5	PXDZ210...	●	●	
special	PXDH2160-PC	XP3425	21,6	PXDZ210...	●	●	
special	PXDH2170-PC	XP3425	21,7	PXDZ210...	●	●	
special	PXDH2180-PC	XP3425	21,8	PXDZ210...	●	●	
special	PXDH2190-PC	XP3425	21,9	PXDZ210...	●	●	
7831220	PXDH2200-PC	XP3425	22	PXDZ220...	●	●	
special	PXDH2210-PC	XP3425	22,1	PXDZ220...	●	●	
special	PXDH2220-PC	XP3425	22,2	PXDZ220...	●	●	
special	PXDH2230-PC	XP3425	22,3	PXDZ220...	●	●	
7831224	PXDH2240-PC	XP3425	22,4	PXDZ220...	●	●	
7831225	PXDH2250-PC	XP3425	22,5	PXDZ220...	●	●	
special	PXDH2260-PC	XP3425	22,6	PXDZ220...	●	●	
special	PXDH2270-PC	XP3425	22,7	PXDZ220...	●	●	
special	PXDH2280-PC	XP3425	22,8	PXDZ220...	●	●	
special	PXDH2290-PC	XP3425	22,9	PXDZ220...	●	●	
7831230	PXDH2300-PC	XP3425	23	PXDZ230...	●	●	
special	PXDH2310-PC	XP3425	23,1	PXDZ230...	●	●	
special	PXDH2320-PC	XP3425	23,2	PXDZ230...	●	●	
7831356	PXDH2325-PC	XP3425	23,25	PXDZ230...	●	●	
special	PXDH2330-PC	XP3425	23,3	PXDZ230...	●	●	
special	PXDH2340-PC	XP3425	23,4	PXDZ230...	●	●	
7831235	PXDH2350-PC	XP3425	23,5	PXDZ230...	●	●	
special	PXDH2360-PC	XP3425	23,6	PXDZ230...	●	●	
special	PXDH2370-PC	XP3425	23,7	PXDZ230...	●	●	
special	PXDH2380-PC	XP3425	23,8	PXDZ230...	●	●	
special	PXDH2390-PC	XP3425	23,9	PXDZ230...	●	●	
7831240	PXDH2400-PC	XP3425	24	PXDZ240...	●	●	
special	PXDH2410-PC	XP3425	24,1	PXDZ240...	●	●	
special	PXDH2420-PC	XP3425	24,2	PXDZ240...	●	●	
special	PXDH2430-PC	XP3425	24,3	PXDZ240...	●	●	
special	PXDH2440-PC	XP3425	24,4	PXDZ240...	●	●	
7831245	PXDH2450-PC	XP3425	24,5	PXDZ240...	●	●	
special	PXDH2460-PC	XP3425	24,6	PXDZ240...	●	●	
special	PXDH2470-PC	XP3425	24,7	PXDZ240...	●	●	
special	PXDH2480-PC	XP3425	24,8	PXDZ240...	●	●	
special	PXDH2490-PC	XP3425	24,9	PXDZ240...	●	●	
7831250	PXDH2500-PC	XP3425	25	PXDZ250...	●	●	
special	PXDH2510-PC	XP3425	25,1	PXDZ250...	●	●	
special	PXDH2520-PC	XP3425	25,2	PXDZ250...	●	●	
special	PXDH2530-PC	XP3425	25,3	PXDZ250...	●	●	
7831254	PXDH2540-PC	XP3425	25,4	PXDZ250...	●	●	

Drilling | Indexable



Inserts & Heads

PXD HEADS

Drilling | Indexable | Inserts & Heads

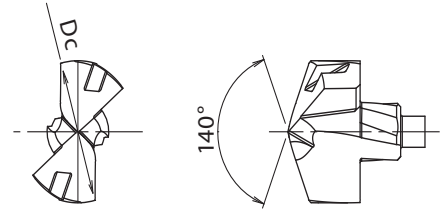
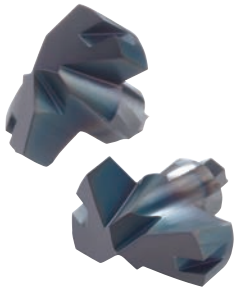

- Applicable head for cast iron

Drilling | Indexable

Inserts & Heads

EDP	Designation	Grade	Dc	Applicable body	K		Price
					dry	water	
7831440	PXDH1400-KC	XP1425	14	PXDZ140...	●	●	
special	PXDH1410-KC	XP1425	14,1	PXDZ140...	●	●	
special	PXDH1420-KC	XP1425	14,2	PXDZ140...	●	●	
special	PXDH1430-KC	XP1425	14,3	PXDZ140...	●	●	
special	PXDH1440-KC	XP1425	14,4	PXDZ140...	●	●	
7831445	PXDH1450-KC	XP1425	14,5	PXDZ145...	●	●	
special	PXDH1460-KC	XP1425	14,6	PXDZ145...	●	●	
special	PXDH1470-KC	XP1425	14,7	PXDZ145...	●	●	
special	PXDH1480-KC	XP1425	14,8	PXDZ145...	●	●	
special	PXDH1490-KC	XP1425	14,9	PXDZ145...	●	●	
7831450	PXDH1500-KC	XP1425	15	PXDZ150...	●	●	
special	PXDH1510-KC	XP1425	15,1	PXDZ150...	●	●	
special	PXDH1520-KC	XP1425	15,2	PXDZ150...	●	●	
special	PXDH1530-KC	XP1425	15,3	PXDZ150...	●	●	
special	PXDH1540-KC	XP1425	15,4	PXDZ150...	●	●	
7831455	PXDH1550-KC	XP1425	15,5	PXDZ150...	●	●	
special	PXDH1560-KC	XP1425	15,6	PXDZ150...	●	●	
special	PXDH1570-KC	XP1425	15,7	PXDZ150...	●	●	
special	PXDH1580-KC	XP1425	15,8	PXDZ150...	●	●	
special	PXDH1590-KC	XP1425	15,9	PXDZ150...	●	●	
7831460	PXDH1600-KC	XP1425	16	PXDZ160...	●	●	
special	PXDH1610-KC	XP1425	16,1	PXDZ160...	●	●	
special	PXDH1620-KC	XP1425	16,2	PXDZ160...	●	●	
special	PXDH1630-KC	XP1425	16,3	PXDZ160...	●	●	
special	PXDH1640-KC	XP1425	16,4	PXDZ160...	●	●	
7831465	PXDH1650-KC	XP1425	16,5	PXDZ160...	●	●	
special	PXDH1660-KC	XP1425	16,6	PXDZ160...	●	●	
7831467	PXDH1670-KC	XP1425	16,7	PXDZ160...	●	●	
special	PXDH1680-KC	XP1425	16,8	PXDZ160...	●	●	
special	PXDH1690-KC	XP1425	16,9	PXDZ160...	●	●	
7831470	PXDH1700-KC	XP1425	17	PXDZ170...	●	●	
special	PXDH1710-KC	XP1425	17,1	PXDZ170...	●	●	
special	PXDH1720-KC	XP1425	17,2	PXDZ170...	●	●	
special	PXDH1730-KC	XP1425	17,3	PXDZ170...	●	●	
special	PXDH1740-KC	XP1425	17,4	PXDZ170...	●	●	
7831475	PXDH1750-KC	XP1425	17,5	PXDZ170...	●	●	
special	PXDH1760-KC	XP1425	17,6	PXDZ170...	●	●	
special	PXDH1770-KC	XP1425	17,7	PXDZ170...	●	●	
special	PXDH1780-KC	XP1425	17,8	PXDZ170...	●	●	
special	PXDH1790-KC	XP1425	17,9	PXDZ170...	●	●	
7831480	PXDH1800-KC	XP1425	18	PXDZ180...	●	●	
special	PXDH1810-KC	XP1425	18,1	PXDZ180...	●	●	
special	PXDH1820-KC	XP1425	18,2	PXDZ180...	●	●	
special	PXDH1830-KC	XP1425	18,3	PXDZ180...	●	●	
special	PXDH1840-KC	XP1425	18,4	PXDZ180...	●	●	
7831485	PXDH1850-KC	XP1425	18,5	PXDZ180...	●	●	
special	PXDH1860-KC	XP1425	18,6	PXDZ180...	●	●	
7831487	PXDH1870-KC	XP1425	18,7	PXDZ180...	●	●	
special	PXDH1880-KC	XP1425	18,8	PXDZ180...	●	●	
special	PXDH1890-KC	XP1425	18,9	PXDZ180...	●	●	
7831490	PXDH1900-KC	XP1425	19	PXDZ190...	●	●	
special	PXDH1910-KC	XP1425	19,1	PXDZ190...	●	●	
special	PXDH1920-KC	XP1425	19,2	PXDZ190...	●	●	
special	PXDH1930-KC	XP1425	19,3	PXDZ190...	●	●	
special	PXDH1940-KC	XP1425	19,4	PXDZ190...	●	●	
7831495	PXDH1950-KC	XP1425	19,5	PXDZ190...	●	●	
special	PXDH1960-KC	XP1425	19,6	PXDZ190...	●	●	
special	PXDH1970-KC	XP1425	19,7	PXDZ190...	●	●	
special	PXDH1980-KC	XP1425	19,8	PXDZ190...	●	●	
special	PXDH1990-KC	XP1425	19,9	PXDZ190...	●	●	
7831500	PXDH2000-KC	XP1425	20	PXDZ200...	●	●	

EDP	Designation	Grade	Dc	Applicable body	K		Price
					dry	water	
special	PXDH2010-KC	XP1425	20,1	PXDZ200...	●	●	
special	PXDH2020-KC	XP1425	20,2	PXDZ200...	●	●	
special	PXDH2030-KC	XP1425	20,3	PXDZ200...	●	●	
special	PXDH2040-KC	XP1425	20,4	PXDZ200...	●	●	
7831505	PXDH2050-KC	XP1425	20,5	PXDZ200...	●	●	
special	PXDH2060-KC	XP1425	20,6	PXDZ200...	●	●	
7831507	PXDH2070-KC	XP1425	20,7	PXDZ200...	●	●	
special	PXDH2080-KC	XP1425	20,8	PXDZ200...	●	●	
special	PXDH2090-KC	XP1425	20,9	PXDZ200...	●	●	
7831510	PXDH2100-KC	XP1425	21	PXDZ210...	●	●	
special	PXDH2110-KC	XP1425	21,1	PXDZ210...	●	●	
special	PXDH2120-KC	XP1425	21,2	PXDZ210...	●	●	
special	PXDH2130-KC	XP1425	21,3	PXDZ210...	●	●	
special	PXDH2140-KC	XP1425	21,4	PXDZ210...	●	●	
7831515	PXDH2150-KC	XP1425	21,5	PXDZ210...	●	●	
special	PXDH2160-KC	XP1425	21,6	PXDZ210...	●	●	
special	PXDH2170-KC	XP1425	21,7	PXDZ210...	●	●	
special	PXDH2180-KC	XP1425	21,8	PXDZ210...	●	●	
special	PXDH2190-KC	XP1425	21,9	PXDZ210...	●	●	
7831520	PXDH2200-KC	XP1425	22	PXDZ220...	●	●	
special	PXDH2210-KC	XP1425	22,1	PXDZ220...	●	●	
special	PXDH2220-KC	XP1425	22,2	PXDZ220...	●	●	
special	PXDH2230-KC	XP1425	22,3	PXDZ220...	●	●	
7831524	PXDH2240-KC	XP1425	22,4	PXDZ220...	●	●	
7831525	PXDH2250-KC	XP1425	22,5	PXDZ220...	●	●	
special	PXDH2260-KC	XP1425	22,6	PXDZ220...	●	●	
special	PXDH2270-KC	XP1425	22,7	PXDZ220...	●	●	
special	PXDH2280-KC	XP1425	22,8	PXDZ220...	●	●	
special	PXDH2290-KC	XP1425	22,9	PXDZ220...	●	●	
7831530	PXDH2300-KC	XP1425	23	PXDZ230...	●	●	
special	PXDH2310-KC	XP1425	23,1	PXDZ230...	●	●	
special	PXDH2320-KC	XP1425	23,2	PXDZ230...	●	●	
special	PXDH2330-KC	XP1425	23,3	PXDZ230...	●	●	
special	PXDH2340-KC	XP1425	23,4	PXDZ230...	●	●	
7831535	PXDH2350-KC	XP1425	23,5	PXDZ230...	●	●	
special	PXDH2360-KC	XP1425	23,6	PXDZ230...	●	●	
special	PXDH2370-KC	XP1425	23,7	PXDZ230...	●	●	
special	PXDH2380-KC	XP1425	23,8	PXDZ230...	●	●	
special	PXDH2390-KC	XP1425	23,9	PXDZ230...	●	●	
7831540	PXDH2400-KC	XP1425	24	PXDZ240...	●	●	
special	PXDH2410-KC	XP1425	24,1	PXDZ240...	●	●	
special	PXDH2420-KC	XP1425	24,2	PXDZ240...	●	●	
special	PXDH2430-KC	XP1425	24,3	PXDZ240...	●	●	
special	PXDH2440-KC	XP1425	24,4	PXDZ240...	●	●	
7831545	PXDH2450-KC	XP1425	24,5	PXDZ240...	●	●	
special	PXDH2460-KC	XP1425	24,6	PXDZ240...	●	●	
special	PXDH2470-KC	XP1425	24,7	PXDZ240...	●	●	
special	PXDH2480-KC	XP1425	24,8	PXDZ240...	●	●	
special	PXDH2490-KC	XP1425	24,9	PXDZ240...	●	●	
7831550	PXDH2500-KC	XP1425	25	PXDZ250...	●	●	
special	PXDH2510-KC	XP1425	25,1	PXDZ250...	●	●	
special	PXDH2520-KC	XP1425	25,2	PXDZ250...	●	●	
special	PXDH2530-KC	XP1425	25,3	PXDZ250...	●	●	
7831554	PXDH2540-KC	XP1425	25,4	PXDZ250...	●	●	

PXD HEADS

Drilling | Indexable | Inserts & Heads

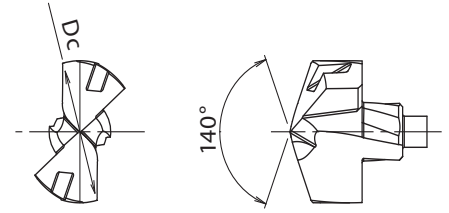

- Applicable head for non ferrous metals

EDP	Designation	Grade	Dc	Applicable body	N		Price
					dry	water	
7831740	PXDH1400-NC	CF225	14	PXDZ140...	●	●	
special	PXDH1410-NC	CF225	14,1	PXDZ140...	●	●	
special	PXDH1420-NC	CF225	14,2	PXDZ140...	●	●	
special	PXDH1430-NC	CF225	14,3	PXDZ140...	●	●	
special	PXDH1440-NC	CF225	14,4	PXDZ140...	●	●	
7831745	PXDH1450-NC	CF225	14,5	PXDZ145...	●	●	
special	PXDH1460-NC	CF225	14,6	PXDZ145...	●	●	
special	PXDH1470-NC	CF225	14,7	PXDZ145...	●	●	
special	PXDH1480-NC	CF225	14,8	PXDZ145...	●	●	
special	PXDH1490-NC	CF225	14,9	PXDZ145...	●	●	
7831750	PXDH1500-NC	CF225	15	PXDZ150...	●	●	
special	PXDH1510-NC	CF225	15,1	PXDZ150...	●	●	
special	PXDH1520-NC	CF225	15,2	PXDZ150...	●	●	
special	PXDH1530-NC	CF225	15,3	PXDZ150...	●	●	
special	PXDH1540-NC	CF225	15,4	PXDZ150...	●	●	
7831755	PXDH1550-NC	CF225	15,5	PXDZ150...	●	●	
special	PXDH1560-NC	CF225	15,6	PXDZ150...	●	●	
special	PXDH1570-NC	CF225	15,7	PXDZ150...	●	●	
special	PXDH1580-NC	CF225	15,8	PXDZ150...	●	●	
special	PXDH1590-NC	CF225	15,9	PXDZ150...	●	●	
7831760	PXDH1600-NC	CF225	16	PXDZ160...	●	●	
special	PXDH1610-NC	CF225	16,1	PXDZ160...	●	●	
special	PXDH1620-NC	CF225	16,2	PXDZ160...	●	●	
special	PXDH1630-NC	CF225	16,3	PXDZ160...	●	●	
special	PXDH1640-NC	CF225	16,4	PXDZ160...	●	●	
7831765	PXDH1650-NC	CF225	16,5	PXDZ160...	●	●	
special	PXDH1660-NC	CF225	16,6	PXDZ160...	●	●	
7831767	PXDH1670-NC	CF225	16,7	PXDZ160...	●	●	
special	PXDH1680-NC	CF225	16,8	PXDZ160...	●	●	
special	PXDH1690-NC	CF225	16,9	PXDZ160...	●	●	
7831770	PXDH1700-NC	CF225	17	PXDZ170...	●	●	
special	PXDH1710-NC	CF225	17,1	PXDZ170...	●	●	
special	PXDH1720-NC	CF225	17,2	PXDZ170...	●	●	
special	PXDH1730-NC	CF225	17,3	PXDZ170...	●	●	
special	PXDH1740-NC	CF225	17,4	PXDZ170...	●	●	
7831775	PXDH1750-NC	CF225	17,5	PXDZ170...	●	●	
special	PXDH1760-NC	CF225	17,6	PXDZ170...	●	●	
special	PXDH1770-NC	CF225	17,7	PXDZ170...	●	●	
special	PXDH1780-NC	CF225	17,8	PXDZ170...	●	●	
special	PXDH1790-NC	CF225	17,9	PXDZ170...	●	●	
7831780	PXDH1800-NC	CF225	18	PXDZ180...	●	●	
special	PXDH1810-NC	CF225	18,1	PXDZ180...	●	●	
special	PXDH1820-NC	CF225	18,2	PXDZ180...	●	●	
special	PXDH1830-NC	CF225	18,3	PXDZ180...	●	●	
special	PXDH1840-NC	CF225	18,4	PXDZ180...	●	●	
7831785	PXDH1850-NC	CF225	18,5	PXDZ180...	●	●	
special	PXDH1860-NC	CF225	18,6	PXDZ180...	●	●	
7831787	PXDH1870-NC	CF225	18,7	PXDZ180...	●	●	
special	PXDH1880-NC	CF225	18,8	PXDZ180...	●	●	
special	PXDH1890-NC	CF225	18,9	PXDZ180...	●	●	
7831790	PXDH1900-NC	CF225	19	PXDZ190...	●	●	
special	PXDH1910-NC	CF225	19,1	PXDZ190...	●	●	
special	PXDH1920-NC	CF225	19,2	PXDZ190...	●	●	
special	PXDH1930-NC	CF225	19,3	PXDZ190...	●	●	
special	PXDH1940-NC	CF225	19,4	PXDZ190...	●	●	
7831795	PXDH1950-NC	CF225	19,5	PXDZ190...	●	●	
special	PXDH1960-NC	CF225	19,6	PXDZ190...	●	●	
special	PXDH1970-NC	CF225	19,7	PXDZ190...	●	●	
special	PXDH1980-NC	CF225	19,8	PXDZ190...	●	●	
special	PXDH1990-NC	CF225	19,9	PXDZ190...	●	●	
7831800	PXDH2000-NC	CF225	20	PXDZ200...	●	●	

EDP	Designation	Grade	Dc	Applicable body	N		Price
					dry	water	
special	PXDH2010-NC	CF225	20,1	PXDZ200...	●	●	
special	PXDH2020-NC	CF225	20,2	PXDZ200...	●	●	
special	PXDH2030-NC	CF225	20,3	PXDZ200...	●	●	
special	PXDH2040-NC	CF225	20,4	PXDZ200...	●	●	
7831805	PXDH2050-NC	CF225	20,5	PXDZ200...	●	●	
special	PXDH2060-NC	CF225	20,6	PXDZ200...	●	●	
7831807	PXDH2070-NC	CF225	20,7	PXDZ200...	●	●	
special	PXDH2080-NC	CF225	20,8	PXDZ200...	●	●	
special	PXDH2090-NC	CF225	20,9	PXDZ200...	●	●	
7831810	PXDH2100-NC	CF225	21	PXDZ210...	●	●	
special	PXDH2110-NC	CF225	21,1	PXDZ210...	●	●	
special	PXDH2120-NC	CF225	21,2	PXDZ210...	●	●	
special	PXDH2130-NC	CF225	21,3	PXDZ210...	●	●	
special	PXDH2140-NC	CF225	21,4	PXDZ210...	●	●	
7831815	PXDH2150-NC	CF225	21,5	PXDZ210...	●	●	
special	PXDH2160-NC	CF225	21,6	PXDZ210...	●	●	
special	PXDH2170-NC	CF225	21,7	PXDZ210...	●	●	
special	PXDH2180-NC	CF225	21,8	PXDZ210...	●	●	
special	PXDH2190-NC	CF225	21,9	PXDZ210...	●	●	
7831820	PXDH2200-NC	CF225	22	PXDZ220...	●	●	
special	PXDH2210-NC	CF225	22,1	PXDZ220...	●	●	
special	PXDH2220-NC	CF225	22,2	PXDZ220...	●	●	
special	PXDH2230-NC	CF225	22,3	PXDZ220...	●	●	
7831824	PXDH2240-NC	CF225	22,4	PXDZ220...	●	●	
7831825	PXDH2250-NC	CF225	22,5	PXDZ220...	●	●	
special	PXDH2260-NC	CF225	22,6	PXDZ220...	●	●	
special	PXDH2270-NC	CF225	22,7	PXDZ220...	●	●	
special	PXDH2280-NC	CF225	22,8	PXDZ220...	●	●	
special	PXDH2290-NC	CF225	22,9	PXDZ220...	●	●	
7831830	PXDH2300-NC	CF225	23	PXDZ230...	●	●	
special	PXDH2310-NC	CF225	23,1	PXDZ230...	●	●	
special	PXDH2320-NC	CF225	23,2	PXDZ230...	●	●	
special	PXDH2330-NC	CF225	23,3	PXDZ230...	●	●	
special	PXDH2340-NC	CF225	23,4	PXDZ230...	●	●	
7831835	PXDH2350-NC	CF225	23,5	PXDZ230...	●	●	
special	PXDH2360-NC	CF225	23,6	PXDZ230...	●	●	
special	PXDH2370-NC	CF225	23,7	PXDZ230...	●	●	
special	PXDH2380-NC	CF225	23,8	PXDZ230...	●	●	
special	PXDH2390-NC	CF225	23,9	PXDZ230...	●	●	
7831840	PXDH2400-NC	CF225	24	PXDZ240...	●	●	
special	PXDH2410-NC	CF225	24,1	PXDZ240...	●	●	
special	PXDH2420-NC	CF225	24,2	PXDZ240...	●	●	
special	PXDH2430-NC	CF225	24,3	PXDZ240...	●	●	
special	PXDH2440-NC	CF225	24,4	PXDZ240...	●	●	
7831845	PXDH2450-NC	CF225	24,5	PXDZ240...	●	●	
special	PXDH2460-NC	CF225	24,6	PXDZ240...	●	●	
special	PXDH2470-NC	CF225	24,7	PXDZ240...	●	●	
special	PXDH2480-NC	CF225	24,8	PXDZ240...	●	●	
special	PXDH2490-NC	CF225	24,9	PXDZ240...	●	●	
7831850	PXDH2500-NC	CF225	25	PXDZ250...	●	●	
special	PXDH2510-NC	CF225	25,1	PXDZ250...	●	●	
special	PXDH2520-NC	CF225	25,2	PXDZ250...	●	●	
special	PXDH2530-NC	CF225	25,3	PXDZ250...	●	●	
7831854	PXDH2540-NC	CF225	25,4	PXDZ250...	●	●	

Drilling | Indexable

Inserts & Heads

CUTTING CONDITIONS

Drilling | Indexables | Cutting conditions

PXD

Vc	Mild Steel Low Carbon Steel SS400 - S10C ~150HB ~500N/mm ²			Carbon Steel S35C - S50C ~210HB ~710N/mm ²			Alloy Steel SCM - SCr - SNCM 16 ~ 30HRC 710 ~ 950N/mm ²			Cast Iron FC250 ~350N/mm ²			Ductile Cast Iron FCD450 - FCD600 400 ~ 600N/mm ²			Aluminium Alloy Casting AC4C - ADC		
	80 ~ 120 m/min			80 ~ 120 m/min			60 ~ 120 m/min			80 ~ 120 m/min			60 ~ 100 m/min			80 ~ 180 m/min		
Ø	S (min ⁻¹)		F (mm/rev)	S (min ⁻¹)		F (mm/rev)	S (min ⁻¹)		F (mm/rev)	S (min ⁻¹)		F (mm/rev)	S (min ⁻¹)		F (mm/rev)	S (min ⁻¹)		F (mm/rev)
14	2.300	0,21	0,35	2.300	0,21	0,35	2.000	0,21	0,35	2.300	0,21	0,35	1.800	0,21	0,35	3.000	0,28	0,42
15	2.100	0,23	0,38	2.100	0,23	0,38	1.900	0,23	0,38	2.100	0,23	0,38	1.700	0,23	0,38	2.800	0,3	0,45
16	2.000	0,24	0,4	2.000	0,24	0,4	1.800	0,24	0,4	2.000	0,24	0,4	1.600	0,24	0,4	2.600	0,32	0,48
17	1.900	0,26	0,43	1.900	0,26	0,43	1.700	0,26	0,43	1.900	0,26	0,43	1.500	0,26	0,43	2.400	0,34	0,51
18	1.800	0,27	0,45	1.800	0,27	0,45	1.600	0,27	0,45	1.800	0,27	0,45	1.400	0,27	0,45	2.300	0,36	0,54
19	1.700	0,29	0,48	1.700	0,29	0,48	1.500	0,29	0,48	1.700	0,29	0,48	1.300	0,29	0,48	2.200	0,38	0,57
20	1.600	0,3	0,5	1.600	0,3	0,5	1.400	0,3	0,5	1.600	0,3	0,5	1.300	0,3	0,5	2.100	0,4	0,6
21	1.500	0,32	0,53	1.500	0,32	0,53	1.400	0,32	0,53	1.500	0,32	0,53	1.200	0,32	0,53	2.000	0,42	0,63
22	1.400	0,33	0,55	1.400	0,33	0,55	1.300	0,33	0,55	1.400	0,33	0,55	1.200	0,33	0,55	1.900	0,44	0,66
23	1.400	0,35	0,58	1.400	0,35	0,58	1.200	0,35	0,58	1.400	0,35	0,58	1.100	0,35	0,58	1.800	0,46	0,69
24	1.300	0,36	0,6	1.300	0,36	0,6	1.200	0,36	0,6	1.300	0,36	0,6	1.100	0,36	0,6	1.700	0,48	0,72
25	1.300	0,38	0,63	1.300	0,38	0,63	1.100	0,38	0,63	1.300	0,38	0,63	1.000	0,38	0,63	1.700	0,5	0,75

1. The indicated speeds and feeds are for water soluble oil.
 2. Suitable cutting fluid is water soluble high density oil (less than 20 times dilution).
 3. Fasten the work material to reduce the possibility of work deformation, deflection of machined surface, or vibration.
 4. A clogged oil hole can lead to a breakage. Make sure that a filter is attached to the oil feeder.



MOUNTING PROCEDURE

Procedure

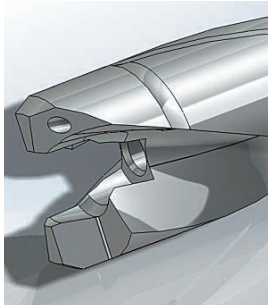

Step 1

Clean attachment area with an air blower.

Any leftover cutting chips may prevent the head from being mounted properly and may cause damages to the tool.



Step 2

Manually attach the head.

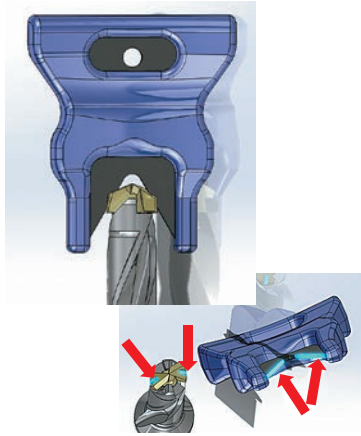

Step 3

Insert the flat metal portion of the designated driver into the groove of the head.

Insert the designated driver firmly into the groove. If the insertion of the designated driver is too shallow, it could damage the flutes.

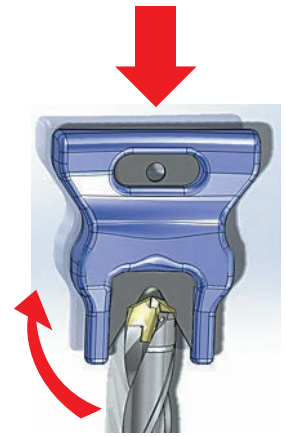

Step 4

Turn the designated driver clockwise and mount the head onto the body.

Mount it firmly and make sure that there is no gap in the area between the head and the body.

After mounting

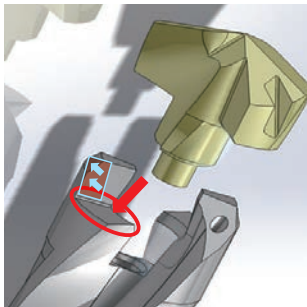

Make sure no clearance gaps is found places marked blue and red by using thickness gauges of 20µm.



If clearance gap is found, please mount and check again after cleaning the mounting area by air blow.

If the clearance gap remains or head can be took off without driver, body is overused and must be changed.

Precaution

- The machining environment that won't loosen the mounting area is essential for PXD because no clamping screws are used.
- Extra caution is necessary for through holes.
- When pulling the drill out from the hole of thin plate without enough holding or material tend to spring back easily, reduce feed rate by 30%.
- Please refer photos for setting of through holes.

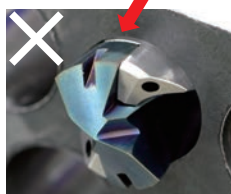

Head should be penetrated no more than 2mm from the shoulder of PXD.



shaping your dreams

OSG EUROPE LOGISTICS

Avenue Lavoisier 1
B-1300 Z.I. Wavre - Nord - Belgium
Tel: +32 10 23 05 07
Fax: +32 10 23 05 51
info@osgeurope.com

OSG BELUX

Avenue Lavoisier 1
B-1300 Z.I. Wavre - Nord - Belgium
Tel: +32 10 23 05 11
Fax: +32 10 23 05 31
info@osg-belgium.com

OSG FRANCE

Parc Icade, Paris Nord 2
Immeuble "Le Rimbaud"
22 Avenue des Nations
CS66191 - 93420 Villepinte - France
Tel: +33 1 49 90 10 10
Fax: +33 1 49 90 10 15
sales@osg-france.com

OSG NETHERLANDS

Bedrijfsweg 5 - 3481 MG Harmelen
Tel: +31 348 44 2764
Fax: +31 348 44 2144
info@osg-nl.com

OSG UK

Shelton house, 5 Bentalls
Pipps Hill Ind Est, Basildon Essex SS14 3BY
Tel: +44 845 305 1066
Fax: +44 845 305 1067
sales@osg-uk.com

SLOVAKIA

Branch office of OSG Europe Logistics s.a.
Tel (SK) +421 2 4329 1295
Tel (BE) +32 10 23 05 07
Fax (BE) +32 10 23 05 51
sales-osgsvk@osgeurope.com

OSG POLAND Sp. z.o.o.

Spółdzielcza 57
05-07 Halinów - Poland
Tel: +22 760 82 71
Fax: +22 760 82 71
osg@osg-poland.com

OSG GERMANY

Karl-Ehmann-Str. 25
D - 73037 Göppingen - Germany
Tel: +49 7161 6064 - 0
Fax: +49 7161 6064 - 444
info@osg-germany.de

OSG SCANDINAVIA

(For Scandinavian countries)
Langebjergvaenget 16
4000 Roskilde - Denmark
Tel: +45 46 75 65 55
Fax: +45 46 75 67 00
osg@osg-scandinavia.com

SWEDEN

Branch office of OSG SCANDINAVIA
Abrahams Gränd 8
295 35 Bromölla - Sweden
Tel: +46 40 41 22 55
Fax: +46 40 41 32 55
osg@osg-scandinavia.com

OSG IBERICA

Bekolarra 4
E - 01010 Vitoria-Gasteiz - Spain
Tel: +34 945 242 400
Fax: +34 945 228 883
osg-comaher@osg-comaher.com

RUSSIA

Butlerova street, 17B, office 5069
117342 Moscow - Russia
Tel: +7 (495) 150 41 54
info@osg-russia.com

OSG TURKEY

Rami Kişla Cad.No:56 Eyüp
Istanbul 34056 - Turkey
Tel:+90 212 565 24 00
Fax: +90 212 565 44 00
info@osg-turkey.com

ROMSAN INTERNATIONAL CO. SRL

Reprezentant Exclusiv OSG
23-25, Nerva Traian Street
031044 Bucuresti - România
Tel: +40 021 322 07 47
Fax: +40 021 321 56 00
romsan.int@romsan.ro

AUSTRIA

Branch office of OSG GERMANY
Messestraße 11
A-6850 Dornbirn
Tel: +49 7161 6064-0
Fax: + 49 7161 6064-444
info@osg-germany.de

OSG ITALIA

Via Cirenaiica n. 52 int. 61/63
I - 10142 Torino - Italy
Tel: +39 0117705211
Fax: +39 0117071402
info@osg-italia.it

WEXO PRÄZISIONSWERKZEUGE GmbH

Siemensstraße 13
D-61352 Bad Homburg
Tel: (06172) 10 62 06
Fax: (06172) 10 62 13
verkauf@wexo.com

OSG EUROPE LOGISTICS S.A.

10/2017 - All rights reserved. © OSG Europe 2017.

The contents of this catalogue are provided to you for viewing only. They are not intended for reproduction either in part or in whole in this or other medium. They cannot be copied, used to create derivation work or used for any reason, by means without the express, written permission of the copyright owner. If prices are stated, they are netto unit-prices and any eventual taxes have to be added. The company is not responsible for any printing error in technical, price and/or any other data.

Tool specifications subject to change without notice.

www.osgeurope.com

